

WHY WAIT ON Custom Built Fittings

Fast, Low Cost Custom Built Irrigation & Industrial Fittings

Available in:

- Steel Powder Coat
- Steel Galvanized
- Aluminum
- Cast Aluminum
- PVC
- Stainless Steel #304

Call, fax, or email your drawing, and we will send you a price.



Section Two



Tow Line Parts

Hose Adapters

Hose

Hose Clamps

Wheel Move

**Wheel Line Technical
Data**

TOW LINE PARTS



Product	Description	Part Number	Weight	List Price
---------	-------------	-------------	--------	------------

TOW COUPLER

4"

3-0310

6.3

22.00



All steel construction, zinc plated.
Includes 2 Gaskets, 1 Quick Drain and 4 Half-Moon Pins.

TOW COUPLER EAR

3/8"

3-0320

0.3

0.50



Made of formed steel.
Welds to coupler body and holds half moon pin.

TOW COUPLER SKID PAN

3-0330

0.6

2.00



Formed steel wear pan.
Welds to bottom of coupler body.

QUICK DRAIN

3-0340

0.0

1.50



Fits into bottom of coupler body to drain line when shut down.
Cotter pin is included.

GASKET (LINDSAY)

4" Drain
4" Non-Drain

3-0350
6-1614

0.3
0.3

2.00
2.40



Drain

Non-Drain

Specify Drain or Non-Drain style.
Fit coupler and stabilizer.
Stabilizer must have Non-Drain Gasket.

TOW LINE PIPE

4" x 40'

3-0380

35.6

169.00



Aluminum.
Comes with Half-Moon Pins, Straps & Bolts installed.

Product	Description	Part Number	Weight	List Price
HALF MOON CLAMP	4"	3-0410	0.9	1.30



Galvanized steel.
Attaches pipe to coupler with tow pins.

HALF MOON BOLT & NUT	Bolt: 5/16" x 5/8"	3-0420	0.1	0.06
	Nut: 5/16"	3-0430	0.1	0.03



Washer included with bolt.

HALF MOON STRAP	1"	3-0440	0.2	0.20
------------------------	----	--------	-----	-------------



Galvanized.
Bolts to back side of half moon clamp to prevent clamp from pulling off of pipe.

HALF MOON PIN	3/8"	3-0450	0.1	1.20
----------------------	------	--------	-----	-------------



Hardened steel, plated.
Connects tow line pipe to coupler and stabilizer.

RISERS







1" Steel tubing. 3/4" Female x 1" Male.	6" FxM	3-0465	0.6	5.00
	12" FxM	3-0460	0.9	6.00
	18" FxM	3-0466	1.1	7.00
	24" FxM	3-0461	1.4	8.00
	30" FxM	3-0467	1.6	9.00
	36" FxM	3-0468	1.9	10.00
	40" FxM	3-0462	2.1	11.00
	48" FxM	3-0469	2.5	12.00
	60" FxM	3-0463	2.9	14.00
	72" FxM	3-0464	3.4	16.00
1" Steel tubing. 1" Male x 1" Male.	12" MxM	3-0470	0.9	6.00
	24" MxM	3-0471	1.4	8.00
	40" MxM	3-0472	2.1	11.00
	60" MxM	3-0473	2.9	14.00
	72" MxM	3-0474	3.4	16.00

Towline / Wheelmove

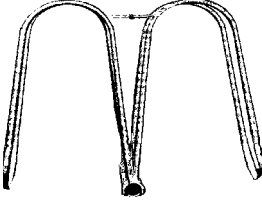
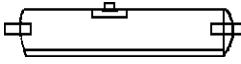
TOW LINE PARTS

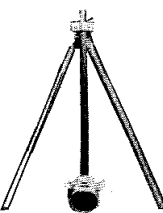

Product	Description	Part Number	Weight	List Price
STABILIZER 	Short: 4"x40'	3-0510	77.0	300.00
	Tall: 4"x60'	3-0520	118.0	350.00
All steel construction. Fit into tow line with half moon pins. Includes gaskets and pins.				
STABILIZER CONVERSION KIT 	4"	3-0530	25.0	160.00
Includes gaskets and pins.				
TOW PLUG 	4"	3-0540	5.5	16.00
Fits into end coupler of tow line as hitch for towing.				
TRI-POD 	----	3-0550	5.0	38.00
All steel construction. Comes complete with Bolts & Nuts. Fits on riser to stabilize end of tow line while watering.				
SHUT-OFF VALVE 	1"	3-0560	0.8	15.00
Order a 1" Close Nipple with this valve. Installed between end coupler and riser.				
CHAIN 	5/0 Size, Plated	3-0640	0.5 /ft	2.50/ft
Horizontal Working Load Limit = 880 lbs.				

Always Open...
SchumacherIrrigation.com
 Your Irrigation Superstore

3 SEGMENT HOSE ADAPTERS

Product	Description	Part Number	Weight	List Price
---------	-------------	-------------	--------	------------

COUPLING (SURE GRIP)

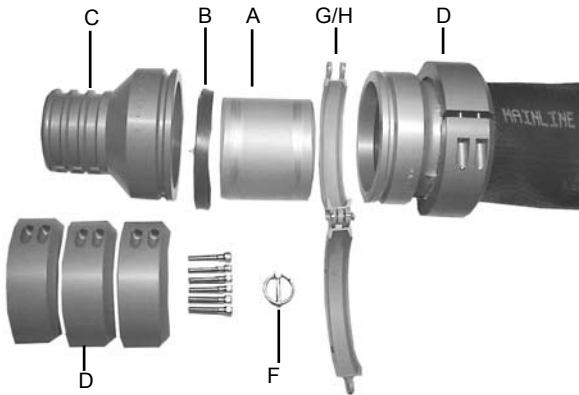

*Complete sets include everything shown above
*Can be pulled with water inside hose.

Complete:	4"	9-5844		\$803.00
	4-1/2"	9-5845		856.00
	5"	9-5846		975.00
	6"	6-9659		790.00
	8"	9-5207		1,365.00

3-Seg Clamp:	4"	D 6-9608		185.00
	4-1/2"	D 6-9609	3.3	185.00
	5"	D 6-9610	1.6	185.00
	6"	D 6-9611	4.5	185.00
	8"	D 9-5184		241.00

Coupler Body:	4"	C 9-7468	-	237.00
	4-1/2"	C 9-7469	-	305.00
	5"	C 9-7470	-	387.00
	5-1/2"	C 9-7471	-	447.00
	6"	C 9-7472	-	222.00
	8"	C 9-7473	-	431.00

Sleeve:	5-1/2" (4" thru 6")	A 9-7445	-	37.00
	8"	A 9-7446	-	77.00

Gasket:	5-1/2" (4" thru 6")	B 9-7447	-	8.00
	8"	B 9-7448	-	9.00

Ring Band Lock:	6" (4" thru 6")	G 9-7449	-	47.00
	6" w/Steel Pin (4" thru 6")	H 9-7450	-	52.00
	8" w/Steel Pin	H 9-7451	-	71.00

Lynch Pin:	5/16"	F 9-7452	-	3.00
-------------------	-------	----------	---	-------------

Towline / Wheelmove

HOSE FITTINGS



FRL	4"	Alum	6-9506	1.5	110.00
MRL	4"	Alum	6-9507	1.2	110.00
FRL	5"	Alum	6-9504	1.8	245.00
MRL	5"	Alum	6-9505	1.4	245.00
FRL	6"	Alum	6-9502	2.4	410.00
MRL	6"	Alum	6-9503	1.8	410.00
FRL 10 ga.	6"	Steel Gal.	6-9500		420.00
MRL 10 ga.	6"	Steel Gal.	6-9501		420.00

*includes 3 segment clamp *Cannot be pulled with water inside hose.

FULL ADAPTER (ALUMINUM)



	4"		6-9889		330.00
	4-1/2"		6-9656		340.00
	5"		6-9657		415.00
	6"		6-9658		436.00
	8"		9-5246		778.00

*includes 3 segment clamp

HALF ADAPTER



Steel:	4"	Steel	6-9648		265.00
	4-1/2"	Steel	6-9649		288.00
	5"	Steel	6-9650		311.00
	6"	Steel	6-9651		370.00
	8"	Steel	9-5877		452.00

Aluminum:	4"	Alum	6-9652		160.00
	4-1/2"	Alum	6-9653		170.00
	5"	Alum	6-9654		210.00
	6"	Alum	6-9655		370.00
	8"	Alum	9-5247		452.00

* Weld-on
* Includes 3 segment clamp

HOSE ADAPTERS



Product	Description	Part Number	Weight	List Price		
HOSE BARB - WELD-ON (BLACK STEEL)		No. of Ribs				
		2"	2	3-0601	0.4	11.00
		2-1/2"	2	9-5014	0.6	12.00
		3"	2	3-0602	0.8	13.00
		4"	3	3-0603	1.8	14.00
		4-1/2"	2	3-0604	1.9	19.00
		5"	2	3-0605	2.0	20.00
		6"	3	3-0606	3.3	21.00
		8"	3	3-0607	5.4	30.00
		10"	2	3-0608	10.6	45.00
		12"	2	3-0609	12.1	52.00
	16"	3	9-7553	18.8	85.00	



Weld-on.

HOSE BARB - WELD-ON (ALUMINUM)	3"	.050	3-0641	0.5	26.00
	4"	.072	3-0652	1.1	29.00
	5"	.078	3-0642	1.4	30.00
	6"	.058	3-0643	1.3	31.00
	8"	.064	3-0644	1.6	32.00



HOSE BARB - WELD-ON (THICK ALUMINUM)	4"		3-0636	1.5	67.00
	4-1/2"		3-0637	-	68.00
	5"		3-0638	1.9	69.00
	6"		3-0639	0.7	76.00

Sharp Barbs



*5" long & 1/4" thick

*with small barbs (as shown) or spaced barbs

KING NIPPLE (PLATED STEEL)	1/2"		6-7000	0.1	2.25
	3/4"		6-7001	0.2	2.35
	1"		6-7002	0.3	2.70
	1-1/4"		6-7003	0.6	4.50
	1-1/2"		6-7004	0.7	5.50
	2"		6-7005	1.1	5.50
	2-1/2"		6-7006	1.7	14.50
	3"		6-7007	2.1	15.00
	4"		6-7008	3.1	17.50
	5"		6-7009	4.1	34.50
	6"		6-7010	12.2	58.00
	8"		6-7011	16.4	85.00
	10"	6-7012	21.8	150.00	
	12"	6-7013	33.2	217.00	



HOSE ADAPTER - FEMALE RL (GALVANIZED STEEL)	3"		6-8050	3.4	24.00
	4"		6-8051	4.5	29.00
	5"		6-8052	5.6	38.00
	6"	12 ga.	3-0681	6.1	55.00
	8"	12 ga.	3-0683	9.9	79.00
	10"	12 ga.	3-0679	14.5	98.00
	12"	12 ga.	3-0664	16.0	115.00



HOSE ADAPTER - MALE RL (GALVANIZED STEEL)	3"		6-8053	3.0	24.00
	4"		6-8054	4.0	29.00
	5"		6-8055	5.0	38.00
	6"	12 ga.	3-0680	6.1	55.00
	8"	12 ga.	3-0682	9.9	79.00
	10"	12 ga.	3-0678	15.0	98.00
	12"	12 ga.	3-0663	14.0	115.00



HOSE ACCESSORIES

Product	Description	Part Number	Weight	List Price
HOSE ADAPTER - B&H (GALVANIZED STEEL)	Hose Barb x Male B & H 2"	6-8060	1.9	29.00
	Hose Barb x Male B & H 3"	6-8061	3.3	33.00
	Hose Barb x Male B & H 4"	6-8062	4.3	37.00
	Hose Barb x Male B & H 5"	6-8063	5.4	57.00
	Hose Barb x Male B & H 6"	9-5322	6.5	70.00
	Hose Barb x Female B & H 2"	6-8056	2.6	25.00
	Hose Barb x Female B & H 3"	6-8057	4.5	29.00
	Hose Barb x Female B & H 4"	6-8058	6.0	33.00
	Hose Barb x Female B & H 5"	6-8059	7.5	48.00
	Hose Barb x Female B & H 6"	9-5321	9.0	55.00

HOSE MENDER (STEEL GALVANIZED)	2"	6-8064	2.2	12.00
	3"	6-8065	3.8	19.00
	4"	6-8066	5.0	29.00
	5"	6-8067	6.3	42.00
	6"	6-8068	7.5	46.00
	8"	6-8069	14.0	69.00

HOSE MENDER (PLATED STEEL)	1/2"	9-6835	0.1	4.00
	3/4"	9-6836	0.2	4.50
	1"	9-6837	0.3	5.00
	1-1/4"	9-6838	0.5	7.00
	1-1/2"	9-6839	0.5	7.00
	2"	9-6840	0.8	9.00
	2-1/2"	9-6841	1.7	18.00
	3"	9-6842	2.4	18.00
	4"	9-6843	2.9	18.00
	5"	9-6844	6.9	25.00
	6"	9-6845	13.2	30.00
	8"	9-6846	20.9	50.00
	10"	9-6847		110.00
	12"	9-6848		160.00

HOSE MENDER (ALUMINUM)	3"	.050	3-0645	0.5	39.00
	4"	.072	3-0653	1.1	41.00
	5"	.078	3-0646	1.4	43.00
	6"	.058	3-0647	1.3	45.00
	8"	.064	3-0648	1.6	47.00

* Applications:
 * PVC layflat for drip irrigation
 * Rubber discharge hose for medium pressure irrigation

TOW HOSE	4" x 12'	3-0655	14.0	265.00
	4" x 17'	3-0650	18.0	310.00

Maximum: #125 psi
 Connects tow line to mainline.
 Both ends Male with hook & band.
 *For other than standard fittings, add \$5.00/end to price.

BAND-IT TOOL	6-9093	165.00
---------------------	--------	--------



HOSE ACCESSORIES



Product	Description	Part Number	Weight	List Price
PREFORMED JUNIOR ADAPTER		6-9094		215.00

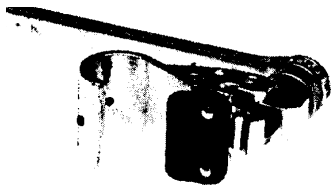

*For use with above tool on preformed clamps

5/8" BANDING (STAINLESS STEEL)	*100'/box	6-9095		161.00
---	-----------	--------	--	--------



* Other sizes are available, please call.

5/8" BAND-IT BUCKLE	*100 buckles/box	6-9096		94.00
----------------------------	------------------	--------	--	-------



* For use with above 5/8" banding

PREFORMED CLAMP	J215	3/4" wide x 5" ID	6-9097	9.00
	J216	3/4" wide x 6" ID	6-9098	10.00



*For use with above tool and jr.adapter
*Stainless Steel

GLUE (FOR HOSE FITTINGS)	1 Quart	Pliobond #20	9-6778	2.1	39.00
-------------------------------------	---------	--------------	--------	-----	-------



WHEELMOVE (WHEELINE, SIDEROLL)

Product	Description	Part Number	Weight	List Price
WHEEL MOVE (COMPLETE)	4" x 1280'	5-0160	Call	Call
	5" x 1280'	5-0161	Call	Call



WHEEL MOVE COUPLER SET (CAST ALUMINUM)	4" Press-on	5-0167	8.0	73.00
	5" Weld-on	5-0168	6.3	80.00



SPRINKLER LEVELER	3/4"	5-0165	2.4	15.00
--------------------------	------	--------	-----	-------



LEVELER ELBOW	1" x 3/4"	5-0166		6.00
----------------------	-----------	--------	--	------



WHEELS

Distance # of Turns



	4'	4" x 48"	18 ga.	5-0170	34.0	89.00	
	4'	5" x 48"	18 ga.	5-0171	35.0	89.00	
60'	4	5'	4" x 58"	18 ga.	5-0172	42.0	85.00
60'	4	5'	5" x 58"	18 ga.	5-0173	42.0	85.00
50'	3	6'	4" x 64"	18 ga.	5-0174	44.0	92.00
50'	3	6'	5" x 64"	18 ga.	5-0175	44.0	92.00
60'	3	7'	4" x 76"	18 ga.	5-0176	56.0	116.00
60'	3	7'	5" x 76"	18 ga.	5-0177	56.0	116.00
50'	2	8'	4" x 96"	16 ga.	5-0178	78.0	238.00
50'	2	8'	5" x 96"	16 ga.	5-0179	78.0	238.00
60'	2	10'	4" x 120"	16 ga.	5-0180	113.0	379.00
60'	2	10'	5" x 120"	16 ga.	5-0181	113.0	379.00

WIND BRACE	4" x 5'	5-0182	8.3	50.00
	4" x 6-7'	5-0183	9.8	55.00



	5" x 5'	5-0184	8.9	70.00
	5" x 6-7'	5-0185	9.8	55.00

Towline / Wheelmove

DISCHARGE HOSE



Product	Description	Part Number	Weight	List Price
---------	-------------	-------------	--------	------------

DISCHARGE HOSE (BLACK RUBBER-HIGH PRESSURE)



Flat Measurement

1-1/2"	300 max psi	2-1/2"	3-0590	0.4 /ft	3.50/ft
2"	300 max psi	3-3/16"	3-0591	0.5 /ft	4.00/ft
2-1/2"	300 max psi	4"	3-0592	0.6 /ft	5.50/ft
3"	300 max psi	4-7/8"	3-0593	0.9 /ft	7.00/ft
4"	200 max psi	6-1/4"	3-0651	0.8 /ft	10.00/ft
4-1/2"	200 max psi	7-1/8"	3-0584	1.2 /ft	17.00/ft
5"	200 max psi	7-7/8"	3-0597	1.0 /ft	16.00/ft
6"	200 max psi	10"	3-0670	1.6 /ft	14.00/ft
8"	150 max psi	13"	3-0671	2.9 /ft	24.00/ft
10"	150 max psi		3-0585	5.1 /ft	38.00/ft
12"	100 max psi		3-0586	5.8 /ft	72.00/ft
16"	34 max psi		9-6850	3.5 /ft	118.00/ft

Features:

1. Ideal for wheeline systems
2. Black rubber covering
3. Sized for use with irrigation fittings
4. Lightweight and flexible
5. Abrasion, UV, and kink resistant
6. Heavy duty discharge for use as a mainline for water and liquid manure, or agricultural and industrial sludge

DISCHARGE HOSE (ORANGE PVC-MEDIUM PRESSURE)



1-1/2"	150 max psi		3-0570	0.2 /ft	1.60/ft
2"	150 max psi		3-0571	0.3 /ft	1.90/ft
2-1/2"	150 max psi		3-0572	0.4 /ft	2.50/ft
3"	150 max psi		3-0573	0.5 /ft	3.70/ft
4"	125 max psi		3-0574	0.8 /ft	6.20/ft
6"	115 max psi		3-0575	1.2 /ft	7.20/ft
8"	70 max psi		3-0576	1.6 /ft	14.20/ft

DISCHARGE HOSE (BLUE PVC-MEDIUM PRESSURE)



1-1/2"	70 max psi		3-0598	0.2 /ft	0.60/ft
2"	65 max psi		3-0594	0.2 /ft	1.00/ft
2-1/2"	60 max psi		3-0599	0.3 /ft	1.15/ft
3"	60 max psi		3-0595	0.4 /ft	1.50/ft
4"	60 max psi		3-0596	0.5 /ft	2.00/ft
5"	40 max psi		9-6817	0.7 /ft	6.20/ft
6"	45 max psi		3-0580	0.9 /ft	3.50/ft
8"	45 max psi		3-0581	1.3 /ft	6.00/ft
10"	35 max psi		3-0582	1.8 /ft	18.00/ft
12"	30 max psi		3-0583	2.0 /ft	25.00/ft
14"	30 max psi		6-9930	2.6 /ft	40.00/ft
16"	30 max psi		6-9931	3.1 /ft	45.00/ft

Features:

1. Ideal for drip irrigation
2. No pig tailing
3. No snaking
4. Twisted yarn assures stability throughout the length of hose
5. Allows many times of use with the convenience of easy coiling for storage

Product	Description	Part Number	Weight	List Price
---------	-------------	-------------	--------	------------

PVC SUCTION HOSE (CORRUGATED-RIGHT SPIRAL)



ID	OD			
1-1/2"	1.87"	6-0807	0.4 /ft	2.30/ft
2"	2.41"	6-0808	0.6 /ft	3.50/ft
2-1/2"	2.87"	3-0900	0.8 /ft	5.00/ft
3"	3.54"	6-0809	1.0 /ft	6.50/ft
4"	4.65"	3-0672	1.7 /ft	10.50/ft
5"	5.73"	3-0675	2.3 /ft	20.00/ft
6"	6.98"	3-0673	4.1 /ft	21.00/ft
8"	9.14"	3-0674	6.3 /ft	36.00/ft
10"	11.30"	3-0901	9.1 /ft	75.00/ft
12"	13.31"	3-0902	10.1 /ft	91.00/ft

* Left Hand Spiral also available. Please call.

Towline / Wheelmove

PVC SUCTION HOSE (SMOOTH)

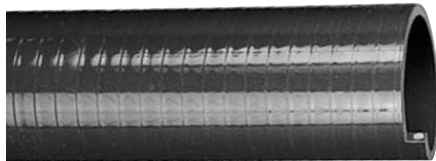

ID	OD			
1-1/2"	1.82"	6-0010	0.5 /ft	2.20/ft
2"	2.34"	6-0011	0.7 /ft	3.20/ft
2 1/2"	2.88"	6-9929	1.0 /ft	4.10/ft
3"	3.40"	6-0012	1.3 /ft	5.00/ft
4"	4.44"	6-0013	1.9 /ft	5.60/ft
5"	5.65"	6-0014	3.1 /ft	15.00/ft
6"	6.56"	6-0015	4.6 /ft	19.00/ft
8"	8.95"	6-0016	7.1 /ft	36.00/ft
10"	11.34"	3-0903	12.4 /ft	87.00/ft
12"	13.39"	3-0904	15.7 /ft	108.00/ft



SUCTION HOSE (BLACK RUBBER)



ID	OD	DB Clamp#	Max PSI			
1-1/2"	1.89"	-	150	6-0800	0.8 /ft	4.80/ft
2"	2.40"	-	150	6-0801	1.0 /ft	5.50/ft
3"	3.46"	400	150	6-0802	1.5 /ft	7.50/ft
4"	4.49"	525	150	6-0803	2.1 /ft	11.00/ft
5"	5.55"	639	150	6-0804	3.3 /ft	21.00/ft
6"	6.54"	769	75	6-0805	3.8 /ft	24.00/ft
8"	8.70"	875	75	6-0806	6.5 /ft	43.00/ft
10"	10.71"	1125	45	3-0905	9.7 /ft	60.00/ft
12"	12.80"	1360	90	3-0906	14.1 /ft	97.00/ft

HOSE CLAMPS



Product	Description		Part Number	Weight	List Price		
	Millimeters	Inches					
T-BOLT HOSE CLAMP (ZINC PLATED)  Zinc Plated Band, Bolt & Nut	26-28	1.02-1.10	0.75" Suction	3-0703	0.2	100	2.00
	29-31	1.14-1.22	1.0" Discharge	3-0704	0.2	100	2.50
	32-35	1.26-1.38	1.0" Suction	3-0705	0.2	100	2.50
	36-39	1.42-1.54		3-0706	0.2	100	2.70
	40-43	1.57-1.69	1.5" Discharge	3-0708	0.2	100	4.20
	44-47	1.73-1.85		9-5433	0.2	100	5.00
	48-51	1.89-2.01	1.5" Suction	3-0709	0.2	100	4.50
	52-55	2.05-2.17	2.0" Discharge	3-0710	0.2	50	4.60
	56-59	2.20-2.32		9-5434	0.2	50	5.50
	60-63	2.36-2.48	2.0" Suction	3-0712	0.2	50	6.20
	64-67	2.52-2.64		3-0713	0.2	50	6.20
	68-73	2.68-2.87	2.5" Discharge	3-0714	0.4	50	6.40
	74-79	2.91-3.11	2.5" Suction	3-0715	0.4	50	6.40
	80-85	3.15-3.35	3.0" Discharge	3-0716	0.4	50	6.50
	86-91	3.39-3.58	3.0" Suction	3-0717	0.4	50	6.50
	92-97	3.62-3.82		9-5435	0.4	50	8.50
	98-103	3.86-4.06		3-0719	0.4	50	6.60
	104-112	4.09-4.41	4.0" Discharge	3-0660	0.5	50	7.00
	113-121	4.45-4.76	4.5" Suction	3-0720	0.5	25	7.00
	122-130	4.80-5.12	4.0"	3-0721	0.5	25	9.50
	131-139	5.16-5.47	5.0" Discharge	3-0722	0.7	25	9.50
	140-148	5.51-5.83	5.0" Suction	3-0723	0.7	25	10.00
	149-161	5.87-6.34	6.0" Discharge	3-0661	0.7	25	10.00
	162-174	6.38-6.85	6.0" Suction	3-0724	0.8	25	11.00
175-187	6.89-7.36	(For 6" Suction Boot)	3-0725	0.9	25	11.00	
188-200	7.40-7.87		3-0726	0.9	25	11.50	
201-213	7.91-8.39	8.0" Discharge	3-0662	0.9	25	12.00	
214-226	8.43-8.90	(For 8" Suction Boot)	3-0727	1.0	25	13.50	
227-239	8.94-9.41		3-0728	1.0	25	13.50	
240-252	9.45-9.92	8.0" Suction	3-0729	1.0	25	15.00	
T-BOLT HOSE CLAMP (STAINLESS STEEL BAND W/ZINC PLATED HARDWARE)  Stainless Steel Band, Zinc Plated Bolt & Nut (Hybrid)	29-31mm	1.14-1.22	1.0" Discharge	9-6886	0.1		4.00
	32-35mm	1.26-1.38	1.0" Suction	9-6887	0.1		4.50
	36-39mm	1.42-1.54		9-6888	0.1		4.50
	40-43mm	1.58-1.69	1.5" Discharge	9-6889	0.1		4.50
	44-47mm	1.73-1.85		9-6890	0.1		6.00
	48-51mm	1.89-2.01	1.5" Suction	9-6891	0.1		6.50
	52-55mm	2.05-2.17	2.0" Discharge	9-6892	0.1		6.50
	56-59mm	2.21-2.32		9-6893	0.1		6.50
	60-63mm	2.36-2.48	2.0" Suction	9-6894	0.1		6.80
	64-67mm	2.52-2.64		9-6895	0.1		6.80
	68-73mm	2.68-2.88	2.5" Discharge	9-6896	0.2		9.00
	74-79mm	2.91-3.11	2.5" Suction	9-6897	0.2		9.50
	80-85mm	3.15-3.35	3.0" Discharge	9-6898	0.2		9.50
	86-91mm	3.39-3.59	3.0" Suction	9-6899	0.2		9.50
	92-97mm	3.62-3.82		9-6900	0.2		9.50
	98-103mm	3.86-4.06		9-6901	0.2		9.50
	104-112mm	4.10-4.41	4.0" Discharge	9-6902	0.2		9.90
	113-121mm	4.45-4.77	4.0" Suction	9-6903	0.2		9.90
	122-130mm	4.81-5.12		9-6904	0.2		9.90
	131-139mm	5.16-5.48	5.0" Discharge	9-6905	0.3		13.00
	140-148mm	5.52-5.83	5.0" Suction	9-6906	0.3		13.00
	149-161mm	5.87-6.34	6.0" Discharge	9-6907	0.3		13.50
	162-174mm	6.38-6.86	6.0" Suction	9-6908	0.3		13.50
	175-187mm	6.90-7.37	(For 6" Suction Boot)	9-6909	0.3		14.00
188-200mm	7.41-7.88		9-6910	0.4		14.00	
201-213mm	7.92-8.39	8.0" Discharge	9-6911	0.4		15.00	
214-226mm	8.43-8.90	(For 8" Suction Boot)	9-6912	0.4		15.00	
226-239mm	8.90-9.42		9-6913	0.4		15.50	
240-252mm	9.46-9.93	8.0" Suction	9-6914	0.4		15.50	
252-275mm	9.92-10.83	10" Discharge	9-7539	-		21.00	
317-330mm	12.48-12.99	12" Discharge	9-7540	-		22.00	
348-374mm	13.70-14.72	14" Discharge**	9-7541	-		23.00	
400-425mm	15.74-16.78	16" Discharge**	9-7542	-		24.00	

**The 14" and 16" Clamps are a two band/
two bolt clamp.

HOSE CLAMPS

Product	Description	Part Number	Weight	List Price	
T-BOLT HOSE CLAMP (ALL STAINLESS STEEL)	Millimeters Inches				
	29-31mm 1.14-1.22	1.0" Discharge	6-9518	0.1	5.00
	32-35mm 1.26-1.38	1.0" Suction	6-9519	0.1	5.00
	36-39mm 1.42-1.54		6-9520	0.1	5.00
	40-43mm 1.58-1.69	1.5" Discharge	6-9521	0.1	5.00
	44-47mm 1.73-1.85		6-9522	0.1	7.00
	48-51mm 1.89-2.01	1.5" Suction	6-9523	0.1	7.00
	52-55mm 2.05-2.17	2.0" Discharge	6-9524	0.1	7.00
	56-59mm 2.21-2.32		6-9525	0.1	7.00
	60-63mm 2.36-2.48	2.0" Suction	6-9526	0.1	7.50
	64-67mm 2.52-2.64		6-9527	0.1	7.50
	68-73mm 2.68-2.88	2.5" Discharge	6-9528	0.2	9.00
	74-79mm 2.91-3.11	2.5" Suction	6-9529	0.2	9.00
	80-85mm 3.15-3.35	3.0" Discharge	6-9530	0.2	9.00
	86-91mm 3.39-3.59	3.0" Suction	6-9531	0.2	9.00
	92-97mm 3.62-3.82		6-9532	0.2	9.50
	98-103mm 3.86-4.06		6-9533	0.2	9.50
	104-112mm 4.10-4.41	4.0" Discharge	6-9534	0.2	11.00
	113-121mm 4.45-4.77	4.0" Suction	6-9535	0.2	11.00
	122-130mm 4.81-5.12		6-9536	0.2	11.00
	131-139mm 5.16-5.48	5.0" Discharge	6-9537	0.3	14.00
	140-148mm 5.52-5.83	5.0" Suction	6-9538	0.3	14.00
	149-161mm 5.87-6.34	6.0" Discharge	6-9539	0.3	14.00
	162-174mm 6.38-6.86	6.0" Suction	6-9540	0.3	15.00
175-187mm 6.90-7.37	(For 6" Suction Boot)	6-9541	0.3	15.00	
188-200mm 7.41-7.88		6-9542	0.4	16.00	
201-213mm 7.92-8.39	8.0" Discharge	6-9543	0.4	16.00	
214-226mm 8.43-8.90	(For 8" Suction Boot)	6-9544	0.4	17.00	
226-239mm 8.90-9.42		6-9545	0.4	17.00	
240-252mm 9.46-9.93	8.0" Suction	6-9546	0.4	17.00	



**All Stainless Steel
Band, Bolt & Nut**

* Ideal for use on waste water and liquid handling hose fittings.
 -All stainless steel.
 -3/4" wide x .025 thick
 -300 Series Stainless Steel band with Stainless steel bolt.
 -A strong, positive method of assembling hose, duct connections, tubing, and component parts. They are used for high torque applications where ordinary hose clamps fail. They provide a 360 degree sealing surface by using a shoe or formed bridge. Nuts are self-locking, vibration resistant with nylon inserts.

Towline / Wheelmove

DOUBLE BOLT CLAMP



3"	# 400	3.5"-3.81"	9-5801	1.5	12.00
4"	# 463	4.06"-4.44"	3-0730	1.8	12.00
4-1/2"	# 525	4.25"-4.94"	9-5802	2.3	17.00
5"	#550	5.00"-5.50"	9-5864	2.1	17.00
5-1/2"	#600	5.50"-6.06"	9-5865	3.0	17.00
6"	# 675	6.13"-6.88"	3-0731	2.7	18.00
6-1/2"	# 769	6.50"-7.56"	9-5803	3.8	22.00
7-7/8"	#818	7.69"-8.19"	9-5866	5.1	23.00
8"	# 875	8.25"-8.88"	3-0732	5.6	24.00
9"	# 988	8.94"-9.88"	9-5804	6.2	38.00
10"	# 1125	9.94"-11.38"	3-0733	9.6	45.00
12"	# 1275	11.19"-13.00"	3-0734	9.5	51.00
13"	# 1360	12.19"-14.00"	9-5805	15.4	75.00
14-1/2"	#1450	13.19"-15.00"	9-5867		80.00
17"	#1700	15.06"-17.50"	9-5868		90.00

DOUBLE BOLT SPIRAL CLAMP (RIGHT HAND SPIRAL)



1.5"		9-5001	0.2	2.00
2"		6-9745	0.4	8.00
2.5"		9-5003	0.5	8.00
3"		6-9746	0.7	9.00
4"		3-0800	1.0	11.10
5"		3-0801	1.8	14.50
6"		3-0802	2.0	18.00
8"		3-0803	2.8	22.50
10"		9-5000	3.5	27.00
12"		9-5002	4.1	28.00

* Left Hand Spiral also available. Please call.